

THE OSCILLATORY CHAMBER

A BREAKTHROUGH IN THE PRINCIPLES OF MAGNETIC FIELD PRODUCTION

by Dr. Jan Pajak[©]

ISBN 0-9597698-2-X

THE OSCILLATORY CHAMBER

The name "oscillatory chamber" is given to a principle of magnetic field production which employs the effects of the oscillation of electric sparks. These sparks circulate around the internal perimeter of a cubical chamber made of an electric insulator and filled with a dielectric gas. The four segmented electrodes joined to the inner surfaces of opposite walls of this chamber perform alone the function of two oscillatory circuits with a spark gap. The appropriate formation of mechanisms of oscillatory discharges occurring both these circuits achieves: (1) the formation of circulating electric sparks which produce a bipolar magnetic field; (2) the elimination of electro-magnetic forces acting on the structure of the chamber; (3) the absorbing and bonding of the energy initially supplied to this device; (4) the elimination of conversion of energy into heat, and (5) the channeling of destructive consequences of the accumulation of huge electric charges into the desired direction. As the final result of such a formation of the oscillatory chamber, this device, when completed, will be able to raise the value of a produced magnetic flux to a level unlimited by theoretical premises. Practically it also means that this source of field will be the first one able to lift itself as the effect of a repulsive interaction with the Earth's magnetic field.

1. Why there is a necessity to replace the electromagnet by the oscillatory chamber

The recent achievements in the development of propulsion systems prompt one to ask the question: What is the remarkable principle of controlled magnetic field production of which today's technology can be so proud? The answer is (at the beginning

of the space exploration era): exactly the same principle as the one which was used over 160 years ago, i.e. the principle discovered by the Danish professor, Hans Oersted in 1820, depending on the application of the magnetic effects created by an electric current flowing through the coils of a conductor. The device utilizing this principle, called an electromagnet, is now one of the most archaic appliances still in common use. We can realize how outdated its operation is from the following example: if the progress in propulsion systems were equal to that of magnetic field production devices, our only mechanical vehicle would still be the steam engine.

Electromagnets possess a whole range of drawbacks, which make it impossible to raise their output above a particular — and not very high — level. These disadvantages can in no way be eliminated, because they result from the principle of operation of these devices alone. Below are listed the most significant drawbacks of electromagnets.

(a) Electro-magnetic containment forces are created which radially tense the coils. The magnetic field produced by an electromagnet interacts with the same coils of the conductor which created it, trying to push them out from its own range (the left-hand rule, often called the motor effect). The deflecting forces acting here are of a type identical to the ones utilized in the operation of electric motors. The electromagnetic containment forces must ultimately be resisted by some form of physical structure. The weight of any really powerful steady-field magnet is related to the mechanical strength of this structure. When the current's flow is high enough, these forces cause the coils to explode and

the total self-destruction of the entire electromagnet results.

(b) A magnetic field is produced only when the device is supplied with an electric current. This requires that a permanent energy supply be provided during the whole period of operation. When the power of a produced field is high, such a requirement necessitates the consumption of the output from a whole electricity plant to serve one electromagnet only.

(c) A significant loss of energy results. The electric current flowing through coils of a conventional electromagnet releases a vast amount of heat (Joule's law of electric heating). This heat not only decreases the energetic efficiency of the magnetic field pr. but also, when the energies involved are high, it leads to a melting of the coils. The superconductive electromagnet removes the heating from a current flowing through resistance. However, it introduces another loss of energy resulting from the necessity to maintain a very low temperature of the coils. This also causes a permanent consumption of energy which decreases the efficiency of such a magnet. It should be noted here that the high magnetic field cancels the effect of superconductivity and thereby restores a resistance to the coils.

(d) The geometrical configuration of electromagnets is formed in such a way that the line of minimal resistance for the electric current does not coincide with the course of the coils. This directs the destructive action of electric energy into the insulation, causing rapid damage (electric breakdown) which initiates the destruction of the entire device.

The only way to eliminate the disadvantages listed above is to apply a completely different principle of magnetic field production. Such a principle, invented by the author, will be presented in later sections of this publication. Because this new principle utilizes the mechanism of oscillatory discharges occurring inside a cubical chamber, it is called an "oscillatory chamber."

The principle of the oscillatory chamber avoids the limitations which prevent an increase of output in electromagnets. Also, it promises a more effective and convenient preparation and exploitation, long life without the necessity of maintenance, very high field-to-weight ratio, and a wide range of applications (e.g. energy storages, propulsion devices, sources of magnetic fields). The explanations that follow (especially the one from section 5) will describe the mechanisms for achieving this. Therefore, it appears highly desirable to promote the fast development of this device in the not too distant future so that it may replace electromagnets presently in use.

2. The principle of operation of the oscillatory chamber

The electric current flowing through a wire is not the only source of a controlled magnetic field. The other well known source is the phenomenon manifesting the flow of electric energy in the purest form, i.e. an electric spark. There are many different methods for the creation of electric sparks, but the purpose considered here is best served by the so-called "oscillatory circuit with a spark gap." The unique property of such a circuit is its ability to absorb, total and utilize the energy supplied to it. This energy then appears in the form of a very lightly damped sequence of oscillatory sparks created by the circuit.

The discovery of the oscillatory circuit with a spark gap was achieved in 1845 by the American physicist, Joseph Henry, who noticed that when a Leyden jar was discharged through coils of wire, the discharge and a spark were oscillatory. A few years later Lord Kelvin, the great English physicist and engineer, proved mathematically that the discharge in a circuit so constituted must manifest itself in the oscillatory form.

a) The electrical inertia of an inductor is the motive force for oscillations in a conventional oscillatory circuit with a spark gap

HAVE YOU ORDERED YOUR NEW "ENERGY UNLIMITED INFORMATION SERVICE CATALOG"?

A MUST for all researchers in non-conventional technology!

For \$5.00 (\$7.00-foreign, surface/ \$8.00-foreign, air) you will receive our catalogue of very rare book titles, experimental papers, patents, proposals, and reports compiled by non-conventional scientists and technologists. This list includes such treasures as *Aircraft, atlantean technology*, Bearden's "Toward a New Electro-Magnetics", the mathematical Treatises of T.J.J. See, Tachyons, Tele-Geo-Dynamics and other Tesla Works, UFO's and Vortexian Mechanics. We have patents galore: T.T. Brown, Coanda, Ecklin, Gray, Johnson, Hooper, Rogers, et al...

Our updated bibliography will suggest hours of reading in a wide range of subjects geared to those of the scientific interest.

Our Tesla Bibliography (which is a FREE bonus included in the catalog) is a very extensive work listing over a hundred articles and references to Tesla and his work. This Bibliography alone is worth \$5.00 but it is a FREE bonus to you ENERGY UNLIMITED supporters.

A \$3.00 credit is applied towards orders over \$20.00.

Figure 1 "a" shows a conventional configuration of the oscillatory circuit with a spark gap. The most distinctive characteristic of this configuration is that it is constituted by connecting together into one closed circuit the complex of three vital elements, i.e. L, C' and E, which take the form of separate devices. These elements are: (1) inductor L, containing a long wire wound into many coils, which provides the circuit with the property called an "inductance"; (2) capacitor C', whose property, called a "capacitance," allows the circuit to accumulate electric charges; (3) electrodes E, whose two parallel plates E_R and E_L , separated by a layer of gas, introduce a "spark gap" to the circuit.

When the electric charges "+q" and "-q" are supplied to the plates P_F and P_B of the capacitor C', this forces the flow of an electric current "i" through the spark gap E and the inductor L. The current "i" must appear in the form of a spark "S" and must also produce the magnetic flux "F." The mechanisms of consecutive energy transformations occurring within the inductor L cause the spark "S," once created between electrodes, to continue oscillating until the energy involved is dissipated.

The oscillatory circuit with a spark gap represents an electric version of the device which produces one of the most common phenomena of nature, an oscillatory motion. The mechanical analogy of that device, well known to everyone, is a swing. In all devices of that type, the occurrence of oscillations is caused by the action of the Conservation Energy Principle. This principle compels the initial energy provided to such an oscillating system to be bound to a continuous process of repetitive transformations into two forms: potential and kinetic. The "potential energy" within the oscillatory circuit is represented by the opposite electric charges "+q" and "-q" carried within both plates of a capacitor — see Figure 1 "a." The electric potential difference introduced by the presence of these charges forces the flow of an electric current "i" through the circuit. In a swing, the same potential energy is introduced by slating the arm of it away from the vertical position. As a result, a load (e.g. a swinging child) is raised to a particular height, forcing later its own acceleration down into the equilibrium position. The second form of energy, the "kinetic energy," within the oscillatory circuit manifests itself in the form of a magnetic flux "F" produced by the inductor L. In a swing this kinetic energy appears as the speed of a load's motion.

The mutual transformation of the potential form of energy into a kinetic one, and vice versa, requires involving a medium which activates the mechanisms of energy conversion. This medium is introduced by the element possessing the property called "inertia." Inertia is a motive force maintaining the oscillations within any oscillating system. It works as a kind of "pump" which forces the transformations of energy from a potential form,

through a kinetic one, back into a reversed potential form. This "pump" always restores the initial amount of potential energy existing at the beginning of the oscillation's cycle, decreased only by its dissipation occurring during the transformations. Therefore the inertial element is the most vital component of every oscillating system. In the oscillatory circuit its function performs the inductor

ENERGY UNLIMITED is pleased to offer:

THREE THOUSAND YEARS OF MAGNETS

by V.P. Kartsev translated by Ann Feltham.

This 92 page book direct from Moscow is an excellent, thorough explanation of magnets, their characteristics, their history and the current use in modern science. For the lay-scientist and trained scientist alike the book covers magnetism in Nature wherein is present information on theories of cosmogony of galaxies and nebulae explained by the presence of a magnetic field. It touches on causes of terrestrial magnetism.

The book recounts the history of discoveries of magnets in different countries; it tells the stories of all the early researchers and shows that the ancients and medieval scholars knew more about them than we suspect.

Mr. Kartsev has done his homework. He tells of the discovery and development of electro-magnetism, electro-static motors, high-field magnets, how they were developed and improved and even the medical uses of magnets.

A superweapon that failed, experiments with plused magnetic fields, the most intense magnetic field ever at man's disposal are all described.

Pictures and illustrations of cyclotrons and their use in thermonuclear reactors along with superconductors are all discussed.

In one chapter titled "CAUTION: Theoretically Impossible Equipment at Work" the author says without attempting in any way to convince the reader of the existence of a "perpetuum mobile," he cannot resist the temptation of saying a few words about "impossible" apparatus. He describes a working d-c transformer that many patent experts had thought, until recently, could not exist.

Don't miss this opportunity to add this valuable book to your research library at the low cost of \$12.00; \$15.50-foreign, surface; \$17.00-foreign air (paper-back copy). Send payment to ENERGY UNLIMITED, P.O. Box 35637, Station D, Albuquerque, N.M. 87176.

L, whose inductance (expressed in henrys) represents electrical inertia. In the swing mechanical inertia is provided by the mass of a load (expressed in kilogrammes). This is the reason why the inductance in the electric oscillations is considered to be the equivalent of the mass from the mechanical oscillations.

To increase mechanical inertia it is necessary to join additional mass to that which is already involved in the energy transformations. The increase of electrical inertia requires the extending of the length of an electric current flow, exposed to the action of its own magnetic field. Practically this is obtained by building an inductor containing many coils of the same wire, closely wound, so that each of them is within the range of the magnetic field produced by the other coils.

Let us review the mechanism of oscillations within the oscillatory circuit shown in Figure 1 "a." We assume that initially the plates P_B and P_F of the capacitor C^1 carry the opposite electric charges $-q$ and $+q$ and that the current $"i"$ within the inductor L is zero. At this instant the whole energy of the circuit is stored in the potential form in the capacitor C^1 . The opposite charges accumulated on the plates of the capacitor C^1 create an electromotive force which activates the current flow $"i."$ To facilitate the interpretation of the sparks' behavior, in this publication the electric current is defined as a movement of electrons from negative to positive. The current $"i"$ appears on the electrodes E in the form of a spark $"S,"$ whereas in the inductor L it produces a magnetic flux $"F."$ As the charge $"q"$ on the plates of the capacitor C^1 decreases, the potential energy stored in the electric field also decreases. This energy is transferred to the magnetic field that appears around the inductor, because of the current $"i"$ that is building up there, thus the electric field decreases, the magnetic field builds up and energy is transformed from the potential to the kinetic form. When all the charge on the capacitor C^1 disappears, the electric field in the capacitor will be zero, and the potential energy stored there will be transferred entirely to the magnetic field of the inductor L . The electromotive force which before caused the current $"i"$ to flow is now eliminated. But the current in the inductor continues to transport the negative charge from the P_B plate of the capacitor C^1 to the P_F plate, because of the electrical inertia. This inertia prevents the current $"i"$ (therefore also the spark $"S"$) from extinction and maintains its flow at the cost of the kinetic energy contained in the magnetic field. Energy now flows from the inductor L back to the capacitor C^1 as the electric field builds up again. Eventually, the energy will have been transferred back completely to the capacitor C^1 . The situation now reached is like the initial situation, except that the capacitor is charged in the reverse

Fig. 1. The transformation of an oscillatory circuit with a spark gap into an oscillatory chamber.

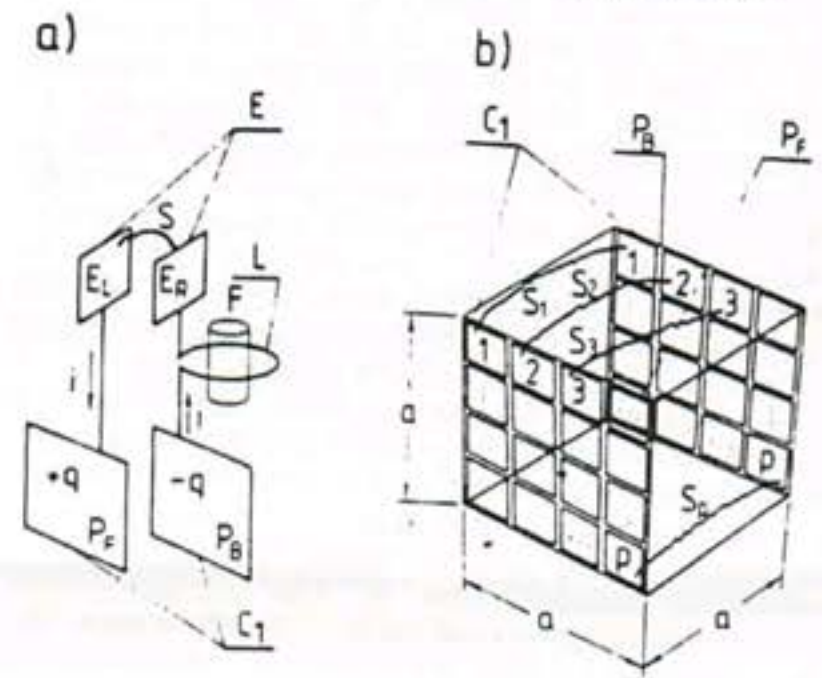

(a) Conventional form of an oscillatory circuit with a spark gap, as it was discovered by J. Henry in 1845. Its three vital elements, i.e. capacitance $'C_1,'$ inductance $'L'$ and spark gap $'E'$ are formed as separate devices.

(b) The modified version of the oscillatory circuit with a spark gap. All three vital elements are concentrated in one device, i.e. in a set of conductive segments $'1, 2, \dots, p'$ forming two plates $'P_F'$ and $'P_B'$ joined to the inner surfaces of the two opposite walls of a cubical chamber made of an electric insulator. Side dimension of the cube is marked by $'a.'$

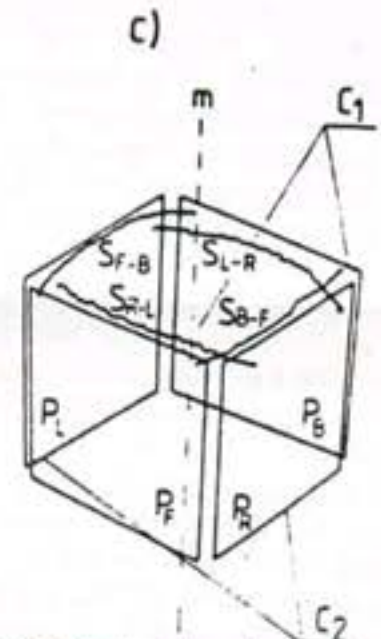

(c) The oscillatory chamber formed by combining together two modified oscillatory circuits $'C_1'$ and $'C_2'$ identical to that presented in part (b) of this diagram. The consecutive appearance of sparks $'S_{L-R}, S_{F-B}, S_{L-R}, S_{B-F}'$ oscillating along the surface of the walls creates a kind of electric arc circulating around the inner perimeter of this chamber and produces a strong magnetic field.

**RENEWABLE RESOURCES
POWER ENGINEERING
INC.**

**INTEGRATED SYSTEMS
at VERY COMPETITIVE PRICES**

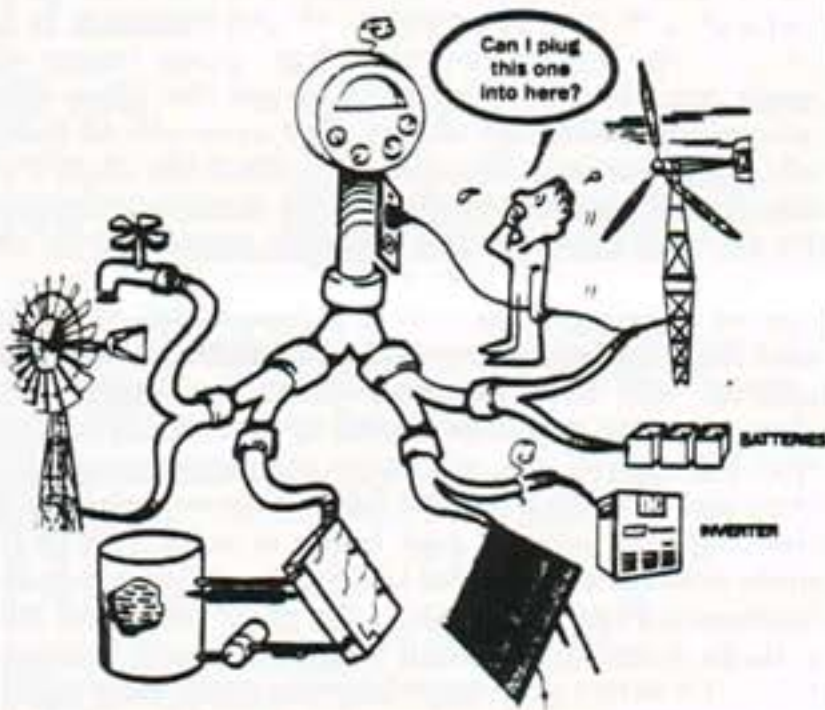

We put it all together—

REMEMBER:

**YOU CAN MIX & MATCH COMPONENTS
BUT . . .
Your equipment must be integrated
for maximum efficiency.**

INDEPENDENT POWER SYSTEM EQUIPMENT:

- MICROHYDRO from \$0.50/W
- PHOTOVOLTAICS from \$4/W
- WIND TURBINES from \$1/W
- DC-AC INVERTERS from \$0.20/W
- BATTERIES from \$20/KWH
- Regulators, Controllers, Switchgear
- GENSETS (Diesel, Propane, Gasoline) from \$0.20/W
- Towers, Racks, Conductor, Enclosures
- PASSIVE SOLAR COMPONENTS from 1¢/BTU
- INTEGRATED WATER-PUMPING SYSTEMS

TALK TO THE ONES THAT KNOW HOW:

**RENEWABLE RESOURCES
POWER ENGINEERING
INC.**

**4609A Lumber Avenue NE
Albuquerque, NM 87109
(505) 883-8828
GB-98-17493**

*Send for our free list of components
with price quotes and compare!*

way. The capacitor will start to discharge again, and the whole process will repeat itself, this time in the opposite direction. Once started, such oscillations continue until the resistance of this process dissipates the energy involved.

b) In the modified oscillatory circuit with a spark gap, the inductance of a stream of sparks replaces the electrical inertia of an inductor

It is known that an electric spark alone introduces a high electric inertia. Therefore a spark is able to replace the inductor in providing the inductance to the circuit. The condition of such a replacement is that the spark must possess the appropriate active length and also that its path must follow a course within the range of its own magnetic field. To achieve this condition, it is impossible to repeat the solution used in the inductor, because an electric spark is reluctant to wind itself into the form of consecutive coils. However, the same can be achieved in another way, through replacing a single spark by a whole stream of sparks jumping simultaneously along parallel paths. Each spark alone in such a stream will be the equivalent of one coil of wire within an inductor. All sparks together will provide the necessary inductance to the circuit.

Figure 1 "b" shows the author's modified version of the oscillatory circuit with a spark gap, which makes use of the electrical inertia of the stream of parallel jumping sparks. The most distinctive characteristic of this version is that all three vital components of the Henry's circuit, i.e. inductance L, capacitance C' and spark gap E, are now provided by the same physical device, which simultaneously performs three different functions. The modified device consists of only a couple of conductive plates P_F and P_B, placed on the inner surfaces of two opposite walls of a cubical chamber made of an electric insulator and filled with a dielectric gas. Each of the plates is divided into a number of small segments insulated each from the other (in the diagram marked by 1, 2, 3, p). Each pair of facing segments marked by the same number, e.g. "p," forms a single component capacitor, which after receiving a sufficient electric charge transforms itself into a couple of electrodes exchanging the electric spark "S_p." The total number of all electric sparks jumping simultaneously in the form of a single compact stream, provides the device with the required inductance. Summarizing the modification described above, one can say that the three separate devices, each of which has provided the conventional circuit with one selected property, are now replaced by the single device (i.e. couple of plates) simultaneously providing all three vital properties, i.e. L, C and E.

If the principle of operation of this modified oscillatory circuit is considered, it becomes obvious that it is identical to the Henry's circuit. After all

segments of both plates are uniformly charged the potential energy of the circuit is built up. When the difference of potentials between plates overcomes the breakdown value "U," the discharge is initiated. This discharge will take the form of a stream of parallel sparks $S^1, S^2, S^3, \dots, S_p$, joining facing segments of the plates. The magnetic field produced by these sparks will gradually absorb the energy stored initially within the electric field. When both plates P_F and P_B reach the equilibrium of potentials, the electrical inertia of sparks will continue the transmission of the charge between them, transforming the kinetic energy contained within the magnetic field back into the potential energy of the electric field. Therefore at the end of the first stage of the oscillation of sparks, the plates will again contain the initial charge, but of the opposite kind. Then the whole process repeats itself but in the reverse direction. If the slight dissipation of energy occurring in this device is somehow compensated for, the process described above will be repeated endlessly.

Such an operation of the modified oscillatory circuit liberates all the electric phenomena from material ties. In effect the electric current does not need to flow through a wire and its value is not the subject of limitation by the properties of the materials used. Also the electric phenomena are exposed to a controlling action that allows them to be channelled into the desired course. These are very important achievements, and as it will be proved later, they are the source of many of the advantages of this device.

The sequence of sparks that oscillate in the device shown in Figure 1 "b," will produce an alternating magnetic field. Because the stream of sparks follows the same path in both directions, this field will also be a vortex, i.e. having all force lines lying on parallel planes. Such a field will not display clear polarity, because its magnetic poles N and S are not fixed. To create a bipolar magnetic field with the steadily positioned magnetic poles N and S, it is necessary to persist one step further in the development of this modified oscillatory circuit.

c) The combination of two modified circuits forms an "oscillatory chamber" producing a bipolar magnetic field

The final form of the circuit considered here is shown in Figure 1 "c." This one is the form to which the name "oscillatory chamber" has been assigned. The oscillatory chamber is constituted by combining together two circuits indicated as C^1 and C^2 , both identical to the one presented in Figure 1 "b." Therefore it consists of four segmented plates (twice as many as in the modified oscillatory circuit), indicated as P_F, P_B, P_R and P_L (i.e. front, back, right and left). Each of these plates contains the same number of segments "p," and faces as the other identical plate, together forming one of the two

cooperating oscillatory circuits. Both of these circuits produce the oscillatory streams of sparks " $S_{R-L}, S_{F-B}, S_{L-R}, S_{B-F}$ " which appear in sequence, with the mutual phase shift between them equal to one quarter of a period of pulsation ($1/4T$).

Before the mechanism of the discharges in this final configuration is analyzed, we should remind ourselves of the action of the electro-magnetic containment forces which will try to deflect the sparks away from the range of the bipolar magnetic field. They are the same forces which cause the explosion of coils in powerful electromagnets. In the case of the oscillatory chamber, these forces will push the stream of sparks against the plate along which the discharge occurs. For example all sparks within the stream S_{R-L} jumping from the plate P_R to the plate P_L will be pushed to the surface of the plate P_F (at this moment the plate P_F increases its own negative charge). For this reason the individual sparks forming consecutive streams $S_{R-L}, S_{F-B}, S_{L-R}$ and S_{B-F} , instead of crossing the paths of the other sparks, will bend themselves at the edges of the chamber and produce a kind of rotating arc. Notice that the sparks can not enter the plate along which they are jumping for the following two reasons: (1) the negative charge just being transferred to this plate creates a repulsive interaction with the sparks (compare Figure 3), and (2) the plate is formed from a large number of small segments each insulated from the other and therefore the resistance against conduction along the plate is not much less than the resistance of the discharge through the dielectric gas in the chamber.

Let us assume that the initial charging of the oscillatory chamber is provided in such a way that first the stream of sparks marked as S_{R-L} will occur, and then after a period of time equal to $t=1/4T$ - the stream S_{F-B} (compare Figure 1 "c" with Figure 3). Let us also assume that right from this initial time, along the axis "m" of the chamber the magnetic flux "F," produced by this device, prevails. This flux pushes sparks against the side walls. After the initial charging of the C^2 capacitor, at time $t=0$, the stream of sparks S_{R-L} will appear, which will jump from plate P_R to plate P_L . These sparks produce the magnetic flux "F" which is totalled to the one already existing in the chamber. This flux bends the paths of all these sparks, pushing them close to the surface of plate P_F . At time $t=1/4T$ the potentials of plates P_R and P_L reach an equilibrium, but the inertia of sparks S_{R-L} still continues transporting charges from P_R P_L , at the cost of the kinetic energy accumulated in the magnetic field. At the same instant ($t=1/4T$) the operation of the second circuit begins and the jump of the S_{F-B} stream of sparks is initiated. Similarly this stream produces a magnetic field which pushes it against the surface of plate P_L . So, in the timespan $t=1/4T$ to $t=1/2T$, there are present two streams of sparks, S_{R-L} and S_{F-B} , the first of which transfers energy from the magnetic to the

electric field, whereas the second one transfers energy from the electric to the magnetic field. At time $t=1/2T$ the plates P_L and P_R reach a difference of potentials equal to the initial one (at $t=0$), but with the opposite location of charges. Therefore the stream of sparks S_{R-L} disappears, whereas the stream S_{L-R} is now initiated. This stream is pushed to the surface of plate P_B . At the same instant ($t=1/2T$) the plates P_F and P_B reach the equilibrium of potentials, so that the stream of sparks S_{F-B} passes into its inertial stage. In the timespan $t=1/2T$ to $t=3/4T$ there are two streams of sparks, i.e. S_{F-B} and S_{L-R} , the first of which consumes the magnetic field, whereas the other produces it. At the instant $t=3/4T$ the sparks S_{F-B} disappear and the sparks S_{B-F} are formed (pushed against plate P_R), whereas the sparks S_{L-R} are passing into their inertial stage. At time $t=1T$ the sparks S_{L-R} also disappear and the sparks S_{R-L} are created (pushed against the plate P_F), whereas the sparks S_{B-F} pass into their inertial stage. With this the whole cycle of spark rotation is closed, and the situation at time $t=1T$ is identical to the one at the initial moment $t=0$. The process that follows will be a repetition of the cycle just described.

The above analysis of the sequence and paths of the sparks reveals a very desirable regularity. The streams of sparks turn into a kind of electric arc combined from the four separate segments. This arc rotates around the inner perimeter of the oscillatory chamber. Such a process, in accordance with the rules of electro-magnetism, must produce a strong, pulsating, bipolar magnetic field. The obtaining of

such a field crowns the long and difficult search for the new method of the magnetic field production presented here.

The principle of operation of the oscillatory chamber does not require a strictly cubical shape, and can be also executed in any chamber consisting of four rectangular side walls of identical dimensions. The only condition is that its cross-section in a plane perpendicular to the magnetic axis must be a square. In this publication, however, for simplicity in deduction, the cubical shape only is considered.

We should also consider the characteristics of the magnetic field produced by the oscillatory chamber. If we analyze the field produced by only a single stream of sparks, it would be a discrete pulsating field of approximately half-sinusoidal course, which, at the points where the sparks reverse, would drop to zero. Because in the chamber two streams of sparks always appear simultaneously, the resultant field will follow the course described approximately by totalling together the series of positive halves of sinusoids. It will still pulsate, but will contain a constant component and a varying component. The relation between both components, as well as the course of the varying component, will be determined by the amount of energy involved in the pulsations.

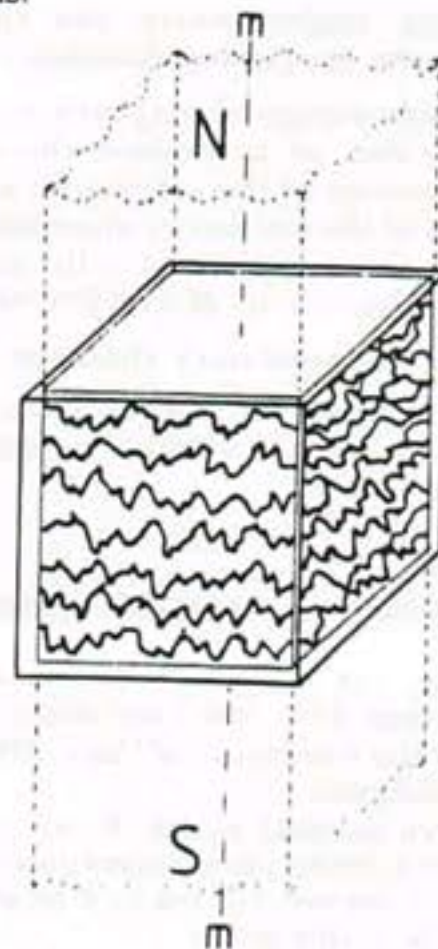

Fig. 2. The assumed appearance of the oscillatory chamber. It will look like a glass cube. Streaks of bright shimmering sparks will run around the inner surfaces of its side walls. Inside it seems to be filled with black smoke. The broken lines indicate the pillar of the magnetic field (invisible to the naked eye) produced by this device, distributed along the 'm' axis.

NEXUS NEWS

The word "NEXUS" means connection, link, or system of links. We at Nexus build links to people, bodies of knowledge, and minds. Nexus News exists as a means of communicating new ideas, exchanging scientific and technical knowledge, and aims to bring about a transformation of humanity to higher and better operating states.

NEXUS NEWS is published 4 times a year and a subscription of \$18.00 per year is requested. NEXUS CENTER is a research and communication center for New Ideas.

NEXUS NEWS is published by William and Connie Hamilton and is copyright © 1985 by William Hamilton and Connie Hamilton.

Send check or money order to:
Nexus News
P.O. Box 11177
Glendale, Ca. 91206

3. The future appearance of the oscillatory chamber

At our present level of technological development there are available excellent, robust construction materials which are good electrical conductors or nonconductors and which are also transparent. Examples parent conductors are silver iodoarsenate glasses or soda-silica glasses. Let us assume that the oscillatory chamber will be made wholly of such transparent materials. Therefore the casual witness will have the illusion that he is observing a very ordinary transparent cube — see Figure 2. Along the inner surfaces of the plain side walls of that cube, the bright gold shimmering sparks will flash. Although these sparks will flicker, they will appear to be frozen in the same positions. Their paths will closely follow the inner surface of the plates, because of the electro-magnetic containment forces pushing the sparks against the walls of the chamber. The inside of the cube will be filled with a dielectric gas looking like black smoke.

Observing this transparent cube, one will find it difficult to imagine that such a plain looking device, to reach the point of its creation, required the accumulation of almost 200 years of human knowledge and experience.

4. The condition under which the sparks will oscillate within the oscillatory chamber

Our present knowledge of magnetic and electric phenomena enables us to deduce the equations expressing the values of the resistance, inductance and capacitance of the oscillatory chamber. Further combination of these equations will lead to the prediction of the behaviour of this device.

a) Resistance of the oscillatory chamber

The general form of the equation for the resistance of any resistor of cross section "A" and length "l" is as follows:

$$R = \rho \cdot \frac{l}{A}$$

In this equation the " ρ " represents the resistivity of a material from which the resistor is made. In our case it will be the maximal resistivity of the dielectric gas that fills the oscillatory chamber, determined for the conditions of the initial moment of electric breakdown.

If in the above general equation, we replace the variables by the specific parameters determined for the oscillatory chamber, i.e. $l=a$ and $A=a^2$ (compare with Figure 1 "b"), this gives:

$$R = \frac{\rho}{a} \quad (1)$$

The equation received represents the resistance of the oscillatory chamber.

b) Inductance of the oscillatory chamber

To determine the inductance of the cubical chamber, the equation for the inductance of a solenoid is used (see "Fundamentals of Physics" by David Halliday and others, John Willey & Sons, 1966):

$$L = \mu \cdot n^2 \cdot l \cdot A$$

When in this equation we substitute: $n = \frac{p}{a}$, $l=a$ and $A=a^2$, the final equation for the inductance of the oscillatory chamber is derived:

$$L = \mu \cdot p^2 \cdot a \quad (2)$$

c) Capacitance of the oscillatory chamber

When we use the well-known equation for the capacitance of a parallel-plate capacitor, of the form:

$$C = \epsilon \cdot \frac{A}{l}$$

and when we apply the substitutions: $A=a^2$, $l=a$; this yields the final equation for the capacitance of the oscillatory chamber:

$$C = \epsilon \cdot a \quad (3)$$

d) The "sparks' motivity factor" and its interpretation

Each of the relations (1), (2) and (3) describes only one selected parameter of the oscillatory chamber. On the other hand, it would be very useful to obtain a single complex factor which would express simultaneously all electromagnetic and design characteristics of this device. Such a factor is now introduced, which will be called a "sparks' motivity factor." Its defining equation is the following:

$$s = \rho \cdot \frac{R}{2} \cdot \sqrt{\frac{C}{L}} \quad (4)$$

Notice, that according to the definition, this "s" factor is dimensionless.

Independently from the above defining equation, the "s" factor has also an interpretative description. This is obtained, when in (4) the variables R, L and C are substituted by the values expressed by equations (1), (2) and (3). When this is done, the following interpretative equation for "s" is received:

$$s = \frac{1}{2a} \cdot \rho \cdot \sqrt{\frac{a}{\mu}} \quad (5)$$

Equation (5) reveals that the "s" factor perfectly represents the current state of all environmental conditions in which the sparks occur, and which determine their course and effectiveness. It describes the kind and consistency of the gas used as a dielectric, and the actual conditions under which this gas is stored. Also it describes the size of the chamber. Therefore the "s" factor constitutes a perfect parameter which is able to inform exactly about the working situation existing within the chamber at any particular instant in time.

The value of the "s" factor can be controlled at the design and at the exploitation stage. At the design stage it is achieved by changing the size "a" of

chamber. At the exploitation stage it requires the change of the pressure of a gas within the chamber or altering its composition. In both cases this influences the constants ρ , μ and ϵ , describing the properties of this gas.

e) Condition for the oscillatory response

From the electric point of view the oscillatory chamber represents a typical RLC circuit. The science on Electric Networks has deduced for such circuits the condition under which, once they are charged, they will maintain the oscillatory response. This condition, presented in the book by Hugh H. Skilling "Electric Network" — John Willey & Sons 1974, takes the form:

$$R^2 < 4 \cdot \frac{L}{C}$$

If the above relation is transformed and then its variables are substituted by the equation (4), it takes the final form:

$$p > s \tag{6}$$

The above condition describes the design requirement for the number "p" of segments separated within the plates of the oscillatory chamber, in relation to the environmental conditions "s" existing in the area where the sparks appear. If this condition is fulfilled, the sparks produced within the oscillatory chamber will acquire an oscillatory character.

To interpretate the condition (6), a possible values taken by the factor "s" should be considered (compare with the equation (5)). Such a consideration allows us to conclude, that in the majority of cases any number "p" of segments should provide the oscillatory sparks.

5. How the oscillatory chamber eliminates the drawbacks of electromagnets

The operation of the oscillatory chamber is formed in such a way, that all drawbacks significant for electromagnets, are completely avoided in this device. The descriptions that follow present the principle of elimination for each basic disadvantage of electromagnets listed in section 1.

a) Mutual neutralization of the two opposite electro-magnetic forces

The unique operation of the oscillatory chamber leads to the formation of two reciprocally acting forces: the Coulomb's attraction force and the electro-magnetic deflecting force. The opposite electric charges, which are accumulated on the facing walls of the chamber, attract each other, causing the formation of the Coulomb's forces that compress this device inwards. The electro-magnetic containment forces, created by the interaction of the magnetic field and the sparks, cause the tension of

the oscillatory chamber outwards. Therefore it is possible to select the design and operational parameters of this device, so that both kinds of forces mentioned above will mutually neutralize each other. As the final result, the physical structure of the chamber is liberated from the obligation to oppose any of these forces.

Figure 3 presents the mechanism of reciprocal compensation of these two interactions described above. For simplicity, all the courses of phenomena within the chamber are shown as linear, independ-

Fig. 3. The mechanism of mutual neutralization of the electro-magnetic forces, simultaneously tensing and compressing the oscillatory chamber.



(a) The four basic phases of operation of the oscillatory chamber. R, L, F, B — the plates of the chamber that together form two cooperating oscillatory circuits; SR-L, SF-B, SL-R, SB-F — the electric sparks that appear in succession during one full cycle of oscillation.

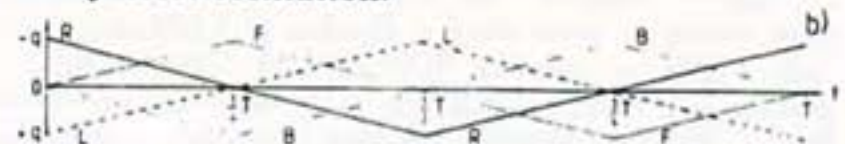

(b) The changes in the potential of the plates during one full cycle of the chamber's operation. T — period of pulsation; t — time; +q, -q — positive and negative charges accumulated on plates.

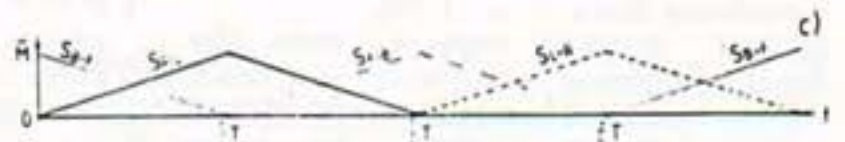

(c) The changes in the electro-magnetic containment forces (M) acting on particular electric sparks.



(d) The changes in the tensing forces (T), caused by the electro-magnetic containment interactions of the opposite electric charges accumulated on the plates. Note that both groups of these forces have a symmetrical course and neutralize each other.

ently of how they occur in reality. But it should be noticed that these phenomena are symmetrical. It means that, for example, if the current in the sparks changes in a particular way, the potentials on the

plates must also change in exactly the same way. Therefore the variation in time of the forces analyzed here will display some kind of an inherent regulation mechanism, in which the course (not the quantity) of the first phenomenon always follows the course of the other phenomenon opposite to this first one.

Part "a" of Figure 3 shows the four basic phases forming the full cycle of the chamber's operation. The description of these phases was already provided in sub-section 2(c) of this publication. Significant for each phase is that two streams of sparks coexist, the first of which (in diagram 3 "a" indicated by the continuous line) transmits energy from the electric field into the magnetic field (active sparks). The second stream (in the diagram indicated by the broken line) in this instant consumes the magnetic field to produce the electric field (inertial sparks).

Part "b" of Figure 3 illustrates the relevant changes of electric charges "q" on the R (right), L (left), F (front) and B (back) plates of the chamber, occurring during each phase of the device's operation. These charges create the Coulomb's forces attracting the facing plates inwards. In this part of the diagram it is visible that, when one couple of plates reaches the maximum of its potentials difference — initiating a discharge between them, the other couple is just in its equilibrium of potentials. Then, simultaneously with the growth of the discharge current flowing between these first couple of plates, the opposite charges on the other couple of plates also grow: The containment forces that tense the chamber outwards are growing accordingly with the value of the discharge current. On the other hand the Coulomb's force of the reciprocal attraction of these other facing plates is growing as well, together with the quantity of opposite electric charges accumulated on them.

Part "c" of Figure 3 shows the changes in the electro-magnetic containment forces $\vec{m} = i \cdot \vec{a} \cdot \vec{H}$, trying to push out the particular sparks from the field's range. Because these forces are proportional to the product of the sparks' current "i" and the magnetic flux density " $\vec{H} = \frac{F}{a \cdot a}$ ", the maximum of the chamber's tension will occur at the instant of time when the discharging plates reach the equilibrium of their potentials. At this same instant of time the other couple of plates, along which the discharge occurs, reach the maximum of potentials difference (compare with part "b" of this diagram) as well as the maximum force of their reciprocal compression.

In the part "d" of Figure 3 the mechanism of mutual compensation of the forces described above is shown. The upper side of this diagram presents the changes in the tension forces "t" which try to pull apart the oscillatory chamber. These forces are caused by the interaction of the magnetic field and the current from the sparks (compare with part "c"

of this Figure). The lower side of diagram "d" presents the changes in the compression forces "C." This compression is caused by the mutual Coulomb's attraction of the facing plates that accumulate the opposite electric charges "q" (compare with the part "b" of Figure 3). Note that whenever a tension force appears (e.g. from the sparks S_{B-F}), always there is also formed a counteracting compression force (e.g. from the Coulomb's attraction of charges q_{R-L}). Both of them act in opposite directions, and follow the same course of changes in time. Therefore both neutralize each other.

It is natural that the compensation of forces displaying inherence in their course as described above, still requires that values match. Therefore further experimental research will be necessary, to select such design and exploitation parameters of the oscillatory chamber, that will provide the full equilibrium for the counteracting forces. As the result of this research, the device can be completed, in which the production of a magnetic field will not be affected by the action of any kind of forces.

b) Independence of the magnetic field production from the continuity and efficiency of the energy supply

One of the most basic attributes of the oscillating systems is their capability for the discrete absorption of the supplied energy, which is then bound into a continuous process of oscillations. An example of this is a child on a swing, which once pushed, then swings a long time without any further work. Practically it means that the energy once supplied to the oscillatory chamber will be tied up within it for a period of time until the circumstances occur which will cause its withdrawal. As will be explained in item (c) of this section, such circumstances can appear only when the chamber is involved in performing some kind of external work.

The other attribute of the oscillating systems is the ability to change the level of energy accumulated in them, by a periodic totalling of its further portions to the resources already stored. In the previous example of a swing, to cause the slanting of a child at a particular height, it is not necessary to apply all the effort at once. It is sufficient to keep pushing gently and to maintain this periodically over a longer timespan. The consequence of this attribute will be that the oscillatory chamber will not require its full reserve of energy at once. The energy supply can be gradual, spread over a very long period of time.

Both of these attributes together give us a practical chance for supplying the unlimited energy required for the production of a magnetic field, without introducing any requirements or limitations concerning the source and the channel which provide this supply.

To help us realize the advantage of the above

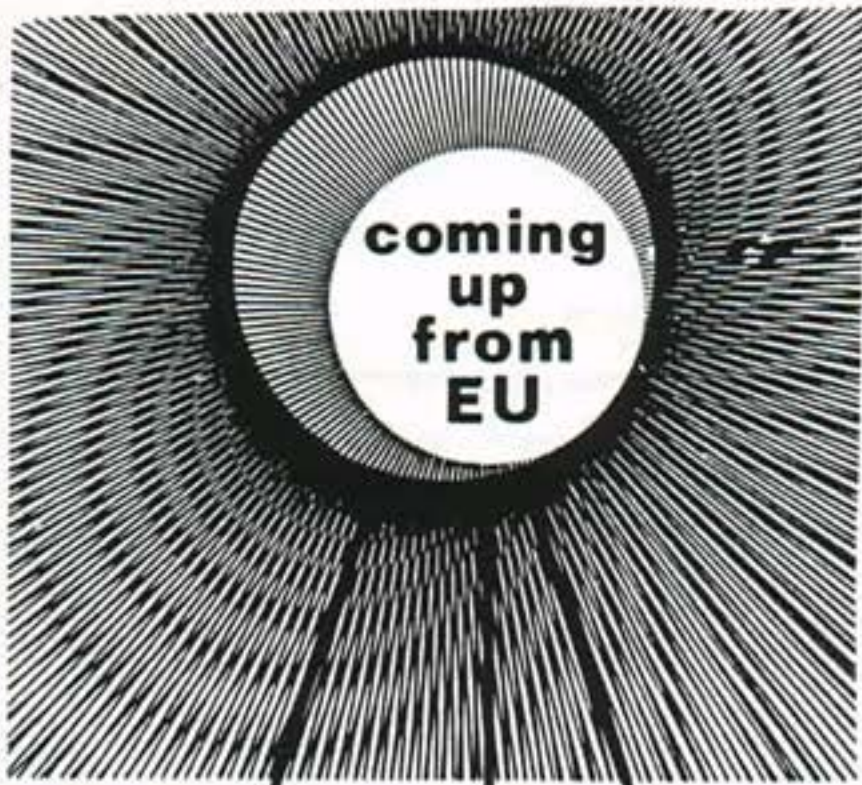

**coming
up
from
EU**

**VORTEXIAN
POWER
SYSTEMS**

**Report
On
Latest
Propulsion
And
Power
R & D**

**Gravity
Research
Around
The
World**

**How
Close
Are We
To
Liftoff?**

**Hydro
Solar**

method of supplying energy to the oscillatory chamber over the one used in electromagnets, we should consider the following example. A child on a swing and an athlete both try to lift a heavy load to a specific height. The child does it almost without effort by accumulating the energy during consecutive oscillations, whereas the athlete needs to use all his strength and still may not achieve his goal.

c) Elimination of energy loss

The sparks appearing in the oscillatory chamber will obviously be the source of a heat conducted into the gas (dielectric) that fills this device. One may expect that it should be the cause of a significant loss of energy. However, in the chamber unique conditions appear which make possible the direct conversion of heat into electricity. This conversion allows for the recovery back into the opposite electric charges of the energy dissipated into a heat produced by the sparks. In this way, the loss of energy within the oscillatory chamber will be eliminated. As the result of such an elimination, all energy provided to this device will be preserved within it forever, unless some kind of external work is done, which will cause its retrieval.

The oscillatory chamber can employ the following two methods of direct conversion of heat into electricity: magnetohydrodynamic (MHD) and electrogasdynamic. The magnetohydrodynamic method requires the movement of a stream of highly ionized gas across a magnetic field. In the electrogasdynamic method the electricity is generated by a high-speed, hot gas which removes the charge (produced for example by a corona discharge) from one electrode and deposits it in another. It should be noted, that the oscillatory chamber provides all conditions necessary for both the above methods to occur. In this device coexist: the magnetic field, electrodes (whose charges fluctuate), and a gas (dielectric) highly ionized by the discharges and caused to rotate by the circulating streams of sparks.

The elimination of loss of energy is not the only advantage of direct conversion of heat into electricity, which may be achieved within the oscillatory chamber. This conversion also introduces an easy method for maintaining the energy supply to the device. To increase the energy resources contained within the oscillatory chamber the additional heating of its dielectric will alone be sufficient. This heating can be obtained, for example, by the circulation of the dielectric through a heat exchanger, or by concentrating on it a beam of sunlight.

Combining the lack of energy loss with the independence of the magnetic field production from the continuity of energy supply (compare with item (b) of this section), provides the oscillatory chamber with the property at present characteristic only for permanent magnets. The magnetic field, once

Table 1. Future devices utilizing the oscillatory chamber which will exploit its energy transformation abilities.

The device No utilizing the oscillatory chamber	Kind of energy		Principle of operation
	Supplied	Obtained	
1 Magnet	Electric current	Magnetic field	Electric energy supplied to the chamber will be transformed into a magnetic field
2 Heater	Electric current	Heat	Hot gas from the chamber will be circulated through a radiator
3 Electric motor	Electric current	Mechanical motion	Waves of controlled magnetic fields produced by the set of chambers will cause a mechanical motion of conductive elements.
4 Transformer	Electric current	Electric current of different param.	Two chambers of different working parameters exchange the energy through their magnetic fields.
5 Combustion engine	Heat	Mechanical motion	Heating of the gas in the chamber provides the energy which is then consumed in the process of producing a mechanical motion.
6 Electricity generator	Heat	Electricity	The gas filling the chamber circulates through a heat exchanger. Energy supplied in the form of heat is converted into the electrical charge and then withdrawn as an electrical current.
7 Generator	Mechanical motion	Electricity	Moving one chamber towards another changes the interactions of their magnetic fields, providing them with energy which then can be withdrawn.

created in this device, will maintain itself through the centuries, if the external consumption of energy does not occur.

d) Releasing the structure of the chamber from the destructive action of electric potentials

The distinctive property of the oscillatory chamber is that it accumulates on the facing plates the electric charges of equal values but opposite signs (the same number of negatives as positives). Under such circumstances the force lines of an electric field from the facing plates will mutually bind themselves together. This causes the charges to display a tendency to jump along the shortest trajectories joining these electrodes. Therefore in the chamber the tendency for a natural flow of electric charges will coincide with the trajectories required for the operation of this device. As a result, the material of the chamber's casing is liberated from the action of the electric charges, whereas all the power of the device's energy is directed into the production of a

magnetic field.

To the channelling of the electric energy flow described above, the oscillatory chamber is entirely different from electromagnets. In the chamber this channelling is achieved by employing natural mechanisms. In electromagnets it was forced artificially by the appropriate formation of the insulator's layers, which pushed the current to flow along the coils, whereas the action of the electric field's force lines was trying to push it across the coils and through the insulation. Therefore there is reason to expect that the oscillatory chambers will possess a life incomparably longer than that of electromagnets, and that their lifespan will not be limited by any electrical wear-out.

6. Advantages of the oscillatory chamber over electromagnets

The elimination of the drawbacks of electromagnets is not the only achievement of the principle of the oscillatory chamber. This device introduces in

addition a number of unique advantages which are not provided by any other device built by man to-date. Let us review the most important of them.

a) Three dimensional transformation of energy

The energy within the oscillatory chamber co-exists in three different forms as: (1) an electric field, (2) a magnetic field, and (3) heat (i.e. a hot dielectrical gas filling the inside of the chamber). These three forms are in a state of continuous transformation from one into the other. Such a situation creates a unique opportunity for the chamber to be exploited in many different ways, when one kind of energy is supplied to it, while another kind is obtained from it. The following kinds of energy can be supplied or obtained: (1) electricity transmitted in the form of an alternating electric current, (2) heat contained in the mass of hot gas, (3) energy transmitted through the changes in the density of the magnetic field, and (4) energy transmitted in the form of the mechanical motion of the chamber. Table 1 combines the most utilitarian applications of the oscillatory chamber, exploiting its capacity for three dimensional transformations of energy.

b) Non-energetic control of the period of field pulsation

The oscillatory chamber will manifest a very high controllability. The key to the manipulation of its operation is the period of pulsations "T." From the RLC circuits we know that the period of their oscillations is described by the equation:

$$T = \frac{2\pi}{\sqrt{\frac{1}{L \cdot C} - \left(\frac{R}{2 \cdot L}\right)^2}} = 2\pi \sqrt{\frac{L \cdot C}{1 - \frac{R^2 C}{4 \cdot L}}}$$

If the defining equation (4) on the factor "s" replaces in the above a combination of R, L and C parameters, whereas equation (1) and equation (3) provide the values for R and C, then this period is described as:

$$T = \frac{\pi \cdot \frac{p}{s} \cdot p \cdot c}{\sqrt{1 - \left(\frac{s}{p}\right)^2}} \quad (7)$$



**THE LAST WORD
IN WINDMILLS IS
THE FIRST IN
PROVEN
QUALITY
AND
RUGGED
DEPENDABILITY**

- Babbit Bearings
- Hot-Dip Galvanized after fabrication
- Galvanized Steel Helmet

- In-Stock Components and Parts to Replace or Repair More Than 80% of all Windmills in Operation

See your local Fiasa Dealer, or give us a call

ESSEX ASSOCIATES, INC.
P.O. Box 29441
Dallas, Texas 75228



is TOPS

Superior Stress-Skin Sandwich Panels

TOPS
for your clients

- A 4'x12', one-step structural load-bearing roof deck for exposed beam construction.
- The highest R-value per thickness of any known roof deck panel.
- Nailbase for asphalt/fiberglass, wood shingles, slate or tiles.

TOPS
for you

- The best insulating roof deck you can use.
- TOPS versatility, simplicity, workability and energy-efficiency make it easy to sell.
- Also a compatible substrate for BUR and single-ply membranes.
- Manufactured by the Homasote Company - a 75 year tradition of quality, energy conservation and commitment to better performing products.

For full details, write:

homasote Company
P.O. Box 7240
West Trenton, NJ 08628-0240

The final question (7) shows how to control the value of "T" within the oscillatory chamber. At the exploitation stage it is sufficient to concentrate controlling activities on the change of the "s" factor. In changing the pressure of the gas filling the chamber or altering its composition, the "s" factor will be influenced. That in turn will introduce the changes in period "T" of the field's pulsations.

Here it should be noted that the chamber uses a very different (and much more convenient) control of oscillations than the one used in electromagnets. In the oscillatory chamber the changes of the gas constants: ν , μ and ϵ , causing the change of "s" are not dependent on the necessity to manipulate the energy contained in the electric and magnetic fields. Therefore all controlling activities here no longer involve wrestling with the power contained inside the chamber. As a result the power of the control devices is independent from the power of the produced field. In electromagnets every change in magnetic field requires manipulations to be conducted on highly energetic currents. Therefore control of electromagnets involved the same powers as field production.

c) Formation of the "twin-chamber capsule" able to control the output without altering the energy involved

Further possibilities of controlling the output from the oscillatory chamber are revealed when two such devices are combined to form the structure called a "twin-chamber capsule" — see Figure 4 "a." This capsule consists of one small chamber located in the centre of the other — a number of times larger than the first. The most convenient shape for the smaller chamber is a square bar located along the magnetic axis of the cubical outer one. The inner device is oriented in the opposite direction towards

BEST BOOK OFFER

With knowledge you really can build your own cost effective private power system. This is why we have included certain basic design information in this brochure and is also why our President, Terrance D. Paul, has written the book "How To Design An Independent Power System."

In 126 clearly written and illustrated pages "How To Design An Independent Power System" develops nine points of thumb the reader can use to easily put together his own power system. It takes the risk out of selecting components, sizing the generator, sizing the batteries, determining what voltage is best and much more. Even the most experienced professional will pick up many useful pointers by reading this book.

To order "How To Design An Independent Power System" send a check or money order for \$8.00 (\$6.95 plus \$1.05 for shipping and handling) to BEST Energy Systems, P.O. Box 280, Necedah, Wisconsin 54646.



Fig. 4. Two basic arrangements of the oscillatory chamber which allow for full control of all the characteristics of the produced magnetic field. The subjects for control are the following properties of the resultant flux (R) conducted to the environment from both these configurations: (1) strength (fluently controlled from zero to maximum), (2) frequency of pulsations, (3) ratio of the amplitude of the field's pulsations to its constant component (F/F_c), (4) character of the field (constant, pulsating, alternating), (5) variation in time (linear, sinusoidal, beat-type curves), (6) polarity (i.e. from which side of the arrangement the N and S poles prevail). In addition configuration 'b' can spin the produced field around its magnetic axis (m).

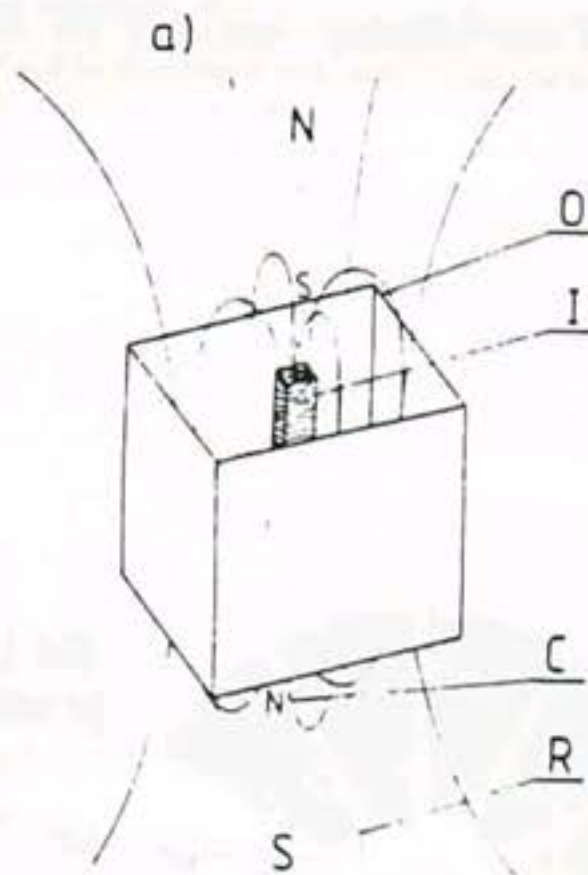

(a) The 'twin-chamber capsule' formed from two oppositely oriented chambers located one inside the other. O — outer chamber, I — inner chamber, C — circulating flux, R — resultant flux.

its host, so that the outputs from both of them would subtract from each other.

In the twin-chamber capsule the appropriate control allows the transmission of energy from one device to the other. Therefore a greater output can be produced by any of the component devices, i.e. by the outer as well as by the inner one. The magnetic flux produced by the device which has the greater output is divided into two parts: (R) the "resultant flux" appearing outside the twin-chamber capsule and (C) the "circulating flux" involved in internal

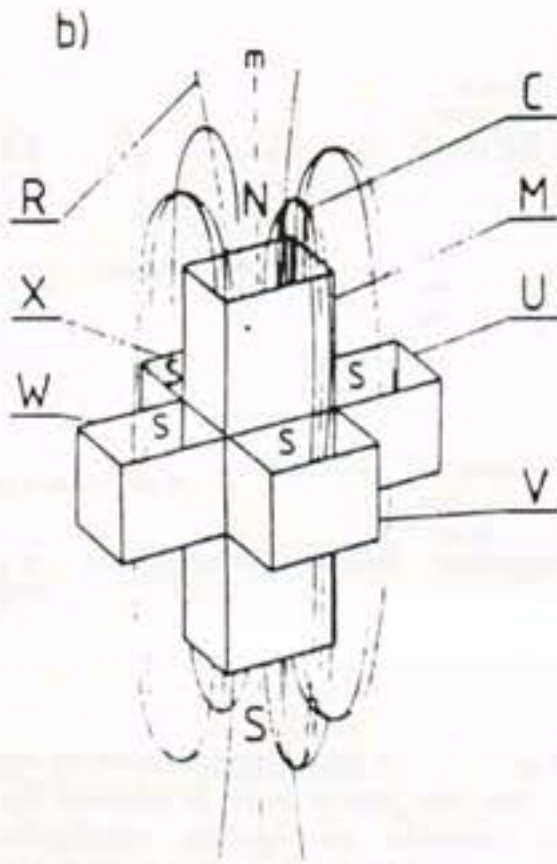

(b) The 'spider configuration' formed from five oscillatory chambers of the same cross area. The four cubical side devices (U, V, W and X) surround the oppositely oriented main chamber (M) which is four times longer. This arrangement is the simplified model of the Magnocraft's propulsion.

looping within the chamber. Having a smaller output is entirely involved in the circulating flux and is not conducted outside the capsule. The magnetic field emitted into the environment by the twin-chamber capsule consists of only the resultant flux, representing a difference from both the component outputs. Therefore in this composition it is possible to control the level of the constant

component of the obtained magnetic field and also the amplitude of pulsations, without introducing any change to the total amount of energy contained in both devices. As a result, the maximization of the resultant pulsating output for any orientation of the magnetic poles can be achieved, as well as any manipulation of the ratio of its constant component to its varying one. Also this output can be decreased to any required value or completely extinguished. If this output were to be extinguished, the chambers would still contain the same amount of energy, and produce equal magnetic fluxes, except that their entire production would be looped inside the devices and no field would be conducted into the environment. Additionally the twin-chamber capsule allows for an almost instant reversal of its own magnetic poles (e.g. the exchange of the north pole into the south pole). This reversal can be achieved merely by appropriate control of the fluxes and without any mechanical rotation of the devices.

The ability to control strictly the character and variations in time of the resultant field in another advantage of the twin-chamber capsule. When the oscillations in both chambers are kept at the same frequencies but opposite phases, then the two counteroriented magnetic fluxes mutually suppress their pulsating components. The resultant field is then non-oscillating (constant in time), identical in character to the one provided by the permanent magnets. On the other hand when the frequencies of pulsations in both chambers are different, a wide range of resultant flux variations in time can be obtained. It is equally easy to produce a pulsating resultant field following one of many possible beat-type curves, as well as a number of alternating fields of different courses. In each case the period of variations can be controlled at the required level.

It should be noted, that all the properties of the twin-chamber capsule can also be achieved by the external arrangement of a number of oscillatory chambers formed in such a way that one device



THE SOLAR DICTIONARY by Carl Breuning & Fred Evangel.

FINALLY - a quick access to the wealth of terms and concepts peculiar to the field of Solar Energy. The Solar Dictionary is a well organized vital reference containing over 1200 simply defined terms, cross referenced to provide a standard working vocabulary, badly needed in the solar field. A welcome and much needed addition to any library. The 55 pages of appendices include:

- S. I. Systems and Units
- Typical U & R Values
- Thermal Properties of Building Materials
- Comparison of Solar Glazing Materials
- List of Solar Micro Computer Methods

THE SOLAR DICTIONARY by Carl Breuning & Fred Evangel, 186 pp., 5 x 8, 53 Illustrations, quality paperback, \$ 9.95. Please add \$ 1.00 for postage & handling for first book and 50¢ for each additional.

Coyne Solar Co. • P.O. Box 1120 • San Juan Pueblo, NM 87566

(central) is oriented in opposition to the others. This kind of configuration of chambers is applied in the concept of the Magnocraft's propulsion — and is described in the other part of this publication. For the purpose of producing the controlled magnetic field, such an arrangement will be prepared in the much simplified version, called a "spider configuration." The spider configuration consists only 5 oscillatory chambers situated as shown in Figure 4 "b." In addition this version can produce a spinning magnetic field.

d) The non-attraction of ferromagnetic objects

The strict control of frequency ($f=1/T$) and amplitude of pulsations (F) in the field produced by the twin-chamber capsule and the spider configuration provides the oscillatory chamber with a very unusual property: it does not attract ferromagnetic objects, even if its output reaches the full power required. This property causes the field produced by the chamber to behave rather like an antigravitational field, not like a magnetic one. Let us analyze how it is possible to achieve this property.

The framed part in Figure 5 shows approximately the curve of variation in time for the typical field produced by the twin-chamber capsule. It takes the course of a beat-type curve, containing the constant component " F_0 " and the varying component " F " of the chamber's output will cause repulsion of all ferromagnetic objects in the vicinity. This repelling force grows with the increase of the amplitude " F " and also with the increase of frequency " f " of the field variations. If the control of the twin-chamber capsule or spider configuration changes the ratio " F/F_0 " of the output, holding constant the frequency " f " of pulsations, then three different kinds of force interaction with ferromagnetic objects can be achieved — compare the diagram in Figure 5. When the varying component " F " dominates over the constant " F_0 " one, then the total interaction with such objects is repulsive. When the constant component " F_0 " is the dominating one, then the resultant interaction is an attraction. However, if the balance between both these components is reached, then the attraction and repulsion come into equilibrium and neutralize each other. In such a case the ferromagnetic objects are not affected by the action of any magnetic force.

The curve of equilibrium between the attraction and repulsion, shown in Figure 5, will frame the parameters of work of the twin-chamber capsule and spider configuration. It is expected that the field produced by the chamber in the majority of cases will lie on this curve. Such a field will not influence in any noticeable way the ferromagnetic objects within its range, but will still be able to perform all work imposed on it.

In special circumstances, however, the field will be re-controlled into the chosen kind of interaction. For example if the militarily oriented system of

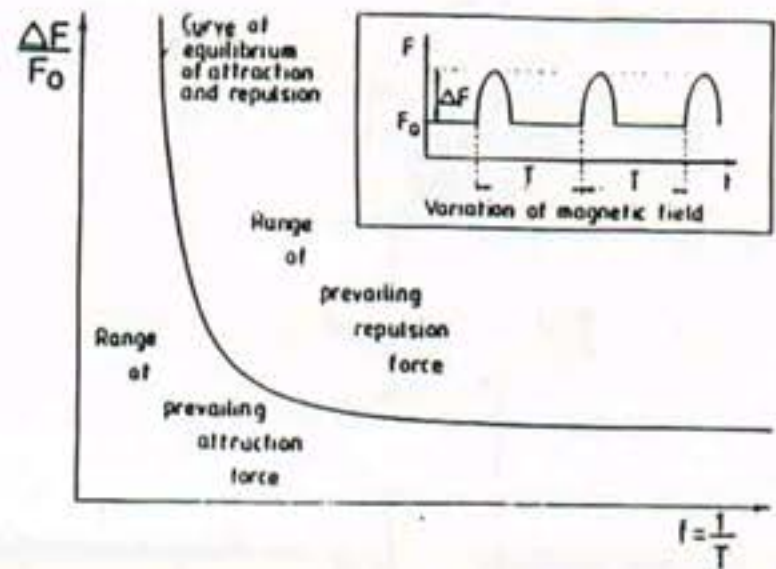

Fig. 5. The curve of the 'interactions in equilibrium' between the magnetic field produced by the twin-chamber capsule or spider configuration and ferromagnetic objects. For the parameters of field defined by this curve, the chambers neither attract nor repel any ferromagnetic object in the vicinity. Their outputs behave more like an 'antigravity field' than a magnetic one. The frame contains the interpretation of the involved parameters of the magnetic field.

chambers is chasing a missile or aeroplane, to intercept it, it will switch on the attracting force to disable the pursued object. But in free space the repelling force will be dominant. Then all dangerous objects, such as meteorites (in the most cases containing iron), cosmic dust or satellites, will be repelled from the chamber's path.

e) Perpetual oscillating — a unique electromagnetic phenomenon allowing the oscillatory chamber to absorb unlimited amounts of energy

Let us return to the example of a swing, and consider what happens when we increase the kinetic energy supplied to this device. The amplitude of oscillations increases proportionally to the energy supplied. We may intensify this process to the point when the top horizontal bar will prevent any further increase of the amplitude. If we still keep providing energy beyond this point, the swing will be destroyed. However, if we use a swing of appropriate design (without a top horizontal bar), then further increase of energy will lead to "perpetual oscillating." In such a kind of oscillating the swing follows a circular course. The energy transformations still exist in it, but the whole oscillating phenomenon obeys different kind of laws. Also the capacitance for potential energy does

not now limit the amount of energy absorbed by the swing.

If we now analyze the work of an oscillatory circuit with a spark gap, we notice that it behaves in a way identical to the swing described above. A conventional circuit is the equivalent of the swing with a top horizontal bar. If we start adding magnetic energy to its inductor, then the growing amplitude of oscillations will lead to the breakdown within the capacitor and to the destruction of the circuit. The oscillatory chamber, however, is the equivalent of the swing allowing for perpetual oscillating. If we add further magnetic energy to the energy contained in a stream of sparks (jumping let us say from the plate P_R to P_L) then this stream will not terminate at the moment when the opposite plates reach the breakdown difference of potentials "U." This is because the inertia of stream will still keep "pumping" electrons from plate P_R to P_L , until all the magnetic energy transforms itself into the electric field. However in this instant both plates also start the discharge in the opposite direction, i.e. from P_L to P_R . Therefore there will be a period of time when two sparks jumping in the opposite directions will appear simultaneously between the same couple of segments. The first of them — inertial — will jump from plate P_R to P_L , whereas the other one — active — will jump from plate P_L to P_R . This will be the electromagnetic equivalent of perpetual oscillating. The oscillatory chamber is the only circuit which allows for the appearance of such a phenomenon.

In general we can define that "the perpetual type of oscillations are attributed only to these oscillating systems, whose ability to absorb the kinetic form of energy significantly overcomes their capacitance for potential energy." Such an ability is purely an attribute of design. It is conditioned by the selected parameters and the appropriate structuring of the system. In the case of the oscillatory chamber it will be determined by the number of sparks which the particular device is capable of creating. This number in turn depends on the number of segments "p" separated within the plates. Let us determine the minimal value of "p" required for the perpetual type of oscillations.

The condition required for causing perpetual oscillating is that the kinetic energy contained in the magnetic field must be greater than the potential one contained in the electric field. This can be written as:

$$\frac{1}{2} L \cdot \frac{U^2}{R^2} > \frac{1}{2} C \cdot U^2$$

If we transform the above relation and substitute the received combination of variables by the one extracted from the equation (4), we will obtain:

$$p > 2 \cdot a$$

(8)

Condition (8) expresses the number of segments "p" separated within the plates of the oscillatory chamber, sufficient for causing perpetual oscillating.

If we build and exploit the chamber in such a way that this condition is always met, then the capacitance of the oscillatory chamber will not be able to introduce any limitations on the amount of energy absorbed by this device. This property, linked with the independence from the continuity and efficiency of the energy supply, will allow the oscillatory chamber to increase the amount of contained energy to a theoretically unlimited level.

EEDO Energy/Economics Program
for Residential Applications

Calculates energy and cost-savings • Geared to non-technical users

Contains:

- Thermal characteristics of building components
- Installation costs
- Yearly maintenance costs
- Weather data for 150 U.S. cities

Performs energy analysis of:

- New home designs
- Energy audits
- Retrofit analysis
- Active and passive solar
- HVAC systems simulations

Determines:

- Life-cycle costs
- Payback period
- Return on investment

IBM-PC™ version of CIRA™ using MS-DOS 2.0

EEDO **Reference Manual**

BURT HILL KOSAR RITTELMANN ASSOCIATES

400 Morgan Center
Butler, Pennsylvania 16001
(412) 285-4761

\$495.00 + shipping
\$20.00 - demo disk

f) Function as an enormously capacious accumulator of energy

The perpetual oscillating just described introduces the ability of the chamber to absorb theoretically unlimited amounts of energy. This property, linked with the capability of the twin-chamber capsule and the spider configuration to completely extinguish the produced field, enables oscillatory chambers to be enormously capacious accumulators of energy. It is expected that there should be no difficulty in storing in a device of about a cubic metre in size, the present equivalent of two months' energy consumption for a medium-sized country.

The ability of the oscillatory chamber to store energy resolves completely the problem of the energy supply during its operation. For the majority of applications it will be sufficient to charge it fully at

 **SOLAR GOLD'™**
AMERICA'S FAVORITE SOLAR AIR SYSTEM



SOLAR GOLD, INC. manufacturers of the "Ultimate BTU Machines" are expanding their dealer and distributor operations. If your company desires a reliable, flexible energy system, for any application, call, write or visit us. We are committed, and prepared to develop and support your organization!

SOLAR GOLD, INC.

TURN THE SUN INTO GOLD™ 306 N. American Rd.
 Cheyenne, Wyoming 82007
 (307) 635-4653



the moment of production, and then simply use the device until this energy is completely withdrawn. The amounts of energy able to be stored in such devices allow them to be operative for hundreds of years without the necessity of renewed recharging.

g) Simplicity of production

The oscillatory chamber will represent probably one of the most sophisticated devices that human technology will complete. This, however, does not mean that it will be difficult to produce. From the technical point of view it will consist mainly of six plain walls, requiring to be precisely dimensioned, finished and assembled. The device has no moving parts, no complicated shapes and no intricate circuits.

The only problem connected with the mass production of oscillatory chambers arises from the enormous increase of energy consumption which it will introduce. It is estimated, that the mastering of such production will increase by tenfold our civilization's energy demands.

7) Future applications of the oscillatory chamber

To-date there does not exist any other technical invention, which has altered the state of our technical environment to the same extent that the completion of the oscillatory chamber will do. The impact this device will have on the materialistic aspects of human life can be compared only to the effect of introduction of computers on the intellectual sphere. One can predict that by the year 2036 almost every active device used by man will consist of some form of the oscillatory chamber. Many structures which at present are passive, such as furniture, buildings, monuments, etc.; will be transformed by the oscillatory chamber into active ones, i.e. moving, altering orientation and adjusting their location to the changing requirements of their users. Let us briefly review the main applications of the oscillatory chamber, trying to forecast what impact they will have on particular fields of human activity.

The unique advantages of the oscillatory chambers will result in this device completely taking over the present functions of electromagnets. Research laboratories capable of using magnetic fields of strengths unattainable today will be able to wrest a number of secrets from nature, introducing a significant step forward in our science and technology. Industry utilizing technologies that are based on the application of super-strong magnetic fields will provide us with a number of products of presently unattainable quality. For example we could produce indestructible rubber and clothes, objects made completely of monocrystals, concrete stronger than steel, etc. Also a new type of material, suiting the magnetic requirements of the oscillatory chamber, will supersede those in use at present.

ELBART SUPER INSULATED TANKS



200 to 1000 Gallons
 Three inches of polyurethane foam for insulation value of R21.

Improved design: Lightweight modules fit through most doorways. Assemble in minutes.

**NEED A BETTER TANK?
 BUY DIRECT AT FACTORY PRICES.**

ELBART MANUFACTURING COMPANY, INC.
 127 W. Main Street, Millbury, MA 01527 (617) 865-9412

The oscillatory chamber will eliminate not only the electromagnets used as separate devices, but also all those which make up parts of other devices, e.g. from electric motors, electricity generators, etc. Such advantages of the chamber as: high power-to-dimensions ratio, ability to introduce long gaps between the time of energy supply and the time of energy consumption, controllability; will result in the wide application of this device for building light vehicles, pumps and generators working far from the energy supply and civilization centres, ship and aeroplane engines, medical instruments, etc.

The twin-chamber capsule providing a constant magnetic field will replace some present-day permanent magnets. Therefore the future equivalents for our speakers, bearings, clutches, grapples, rails, etc.; will all employ oscillatory chambers.

The numerous future applications of the chamber are connected with the ability to store huge amounts of energy. To have an idea of what kind of potentials are involved here, it is enough to realize that the energy needs for today's factories, towns, big ships or aeroplanes can be satisfied by a chamber of pinhead size. All present batteries, accumulators and electricity transmission lines will be replaced by light, much more efficient and rechargeable oscillatory chambers. Built as twin-chamber capsules, they will not yield any magnetic field during such an exploitation.

A wide application of the chamber can also be predicted in all cases where the transformation of energy is required — compare with Table 1. Such devices as for example generators of free energy — exploiting solar radiation, wind, ocean waves, tides — as engines; as air conditioners, etc.; — all can become very efficient when employing the principles of the oscillatory chamber. The transformation of energy will also replace today's transformation of motion. Future mechanisms will be much simpler and lighter, because they will be released from all the devices which presently provide and transform motion. The motion will be created directly in the location where it is working, and in the exact form that is required. For example if a future hobbyist were to build a copy of our present car, he would produce the motion right inside the wheels, therefore the whole engine, gears and transmission would be eliminated.

The oscillatory chambers will also introduce a completely new fashion, which at present has no appropriate technical back-up. It will be the fashion to suspend objects in space. It should be expected that future furniture, household devices, machines and even buildings and elements of architecture will hang in space, supported by the invisible force lines of a magnetic field. One of the consequences of this fashion will be the complete disappearance of the wheel, as all present rolling movements will be replaced by soaring in space. This prediction leads to the philosophical conclusion, that if the pre-

Sun Aire™ Systems offer many heating options



3 COLLECTOR SIZES/4 SYSTEMS

- Sun Space - direct, efficient space heat.
- Sun Bather - simple, effective water heating.
- Sun Combo - heat and water, year-round operation.
- Sun Downer - compact phase-change storage for night time heating.

Sun Aire™ Systems:

- No freezing or boiling
- No chemicals
- No valves or pressure tanks
- Low maintenance

Pre-engineered to simplify specification, sales, and installation.

For more information or dealer nearest you, contact:
Sun Aire™ Industries
(Dealership available)



Check our ratings
Sun Aire™ Systems
are manufactured by
Southwest Solar Industries
Manufacturing Ltd.

"Nobody does it better"



2130 San Mateo, NE
Albuquerque, N.M. 87106
(505) 266-1371

A note on auxiliary heating systems for tight houses . . .

Not only do a home's occupants need adequate ventilation, but heating appliances such as boilers, furnaces and wood-burning stoves need air for combustion. Oxygen is necessary to assure clean, complete burning of fuel without unnecessary smoke or carbon monoxide production.

AIR REQUIREMENTS FOR SOME COMMON APPLIANCES:

Flame-retention head oil burner (*2 fuel oil)	1700 Cu. Ft. per gallon
Atmospheric natural gas burner	3000 Cu. Ft. per therm
Condensing-type natural gas burner	1000 Cu. Ft. per therm
Anthracite coal burner	200 Cu. Ft. per pound

Energy Design Collaborative

is a group of architects and engineers who specialize in energy analysis for institutional, commercial and residential buildings — both existing and on the drawing board. Recent work includes combustion efficiency workshops for servicers of residential heating equipment, sponsored by the New York State Energy Office.



Energy Design Collaborative, Inc.

529 Central Avenue, Scarsdale, NY 10583 (914) 725-1888

columbian Indians had invented the oscillatory chamber, they would have been able to reach their high level of development without even knowing about the use of the wheel.

Enormous potentials are involved in the military

Solar and Energy Conservation Products

Solar Glazings

- Silicone Sealed Insulated Glass—standard or custom sizes with full 10 year warranty
- Curable double glazed acrylic sheet—clear and tints
- Laminated Fiberglass
- Laminated Clear polycarbonate
- Vespene 1304—4 mil UV resistant polycarbonate
- Plexiglas

Glazing Systems

- Solar SureSeal—lenses or white metal glazing systems
- Curable glazing systems

Glazing Accessories

- Silicone caulk
- Corrugated rubber
- Vinyl and butyl tape
- Setting blocks

Solar Greenhouse Kits

- Brother Sun's own Suspense Modular System

Greenhouse Accessories

- Heat Motor automatic vent opener
- Dripless greenhouse exhaust fans
- Duct tape
- Cupressus non-toxic wood preservative
- Max-Mix thermometers
- Indoor/Outdoor thermometers

Windows and Doors

- Marine—quality and variety in wood
- Eagle—aluminum clad wood
- Brode—curable glass in mahogany or pine

Window Insulations

- Window Quilt Insulated shade
- Warm Window roman shades
- Thermal Design overhead roman shade
- Brother's Mylar Energy Shield

Hot Water Systems

- Sun Challenger passive solar water heater
- Ramada Sun-Tech active solar water heater
- Bradford-White high efficiency water tanks
- Comblers
- Bosch instantaneous water heaters—gas and electric

Other Products

- Solar Photovoltaics
- AERO photovoltaics
- Heart Inverters
- Aztec radiant heaters
- Solar screens and shade cloth
- Solar L-Foil selective surface
- Skyline skylights
- Solar and energy conservation books
- Adobe Today Magazine

Come to Brother Sun and visit our solar learning center and talk to our sales representatives for more information on products. We will mail specific information upon request. Please send \$1.00 to handle copying, postage and handling.



Brother Sun

1301 Carrville Road Santa Fe, New Mexico 87501 505/962-5888

THE FARTHER AWAY YOU ARE, THE CLOSER YOU WANT TO BE TO OUR INVERTER.

Independent power systems require the Best — the only static power inverter for alternate energy.

Why? Because Best "M" Series inverters offer these outstanding features: 4 times surge power (to start the induction motors that make our life style possible); high efficiency (typically 90%, which means almost all of the power your storage system has available is converted to usable AC); reliability (design simplicity is our specialty); and great serviceability ("M" stands for modular, which means should a component for any reason fail, it can be replaced easily, quickly and on the spot).

A Best "M" Series inverter ties your alternate energy system together, regardless of



the generating source. If you're serious about putting together a complete alternate energy or remote power generation system, get in touch. We're here to help.



BEST ENERGY SYSTEMS FOR TOMORROW, INC.
P.O. BOX 280
NECEDAH, WISCONSIN 54446

Singular Products.

applications of the chamber. A system of these devices producing whirling magnetic fields will be able to form barriers and mines which in seconds may explosively vaporize every object made of a good electric conductor, entering into their range. Missiles containing systems of chambers may cause instant evaporation of huge constructions made of steel, such as bridges, factories, ships, aeroplanes, rockets, satellites, etc. The rapid releasing of the energy stored within a chamber (e.g. through its detonation) will cause an explosion comparable in effect to the use of an atomic bomb. The only difference will be that the chamber will not pollute the environment by any radioactivity.

The most promising prospects, however, are connected with using the oscillatory chamber for the purpose for which its principle was invented — i.e. for the magnetic propulsion of flying vehicles. Experiments conducted on magnets lead to the conclusion that "every two magnets must produce a force of reciprocal repulsion if only two conditions are met: (1) identical magnetic poles are oriented towards each other (i.e. N of one magnet to the N of the other, whereas S to S), and (2) the magnetic axis of one magnet is tangential to the local course of force lines of the field produced by the other magnet. Because natural phenomena behave continuously, the above repulsive force must also be produced when the first of these magnets is the Earth, Sun or Galaxy, whereas the other one is the oscillatory chamber. In such a case there is the possibility of breaking up the gravity pull by strong magnetic repulsion, and to employ magnetic interactions for propelling the spacecraft. It was determined and published in the article "Teoria rozwoju napędów (The theory of propulsion development)," *Astronautyka (Poland)*, no 5/1976, pp. 16-21; that the output from the source of a magnetic field, having field-to-weight ratio that overcomes the value of 3.45 Wb/kg, is able to lift this source into space as the result of a magnetic repulsion with the Earth's magnetic field. This critical output of 3.45 Wb/kg was called the "starting flux" and it constitutes the magnetic equivalent of "escape velocity" as applied to satellites. Achieving its value, which will open the way for building of a magnetically propelled spacecraft, was the main goal for years of research which led to the invention of the oscillatory chamber.

The spacecraft utilizing the oscillatory chamber for propulsion is called a Magnocraft. The detailed presentation of the design, operation and attributes of the Magnocraft is the subject of a separate treatise, containing over 100 pages of descriptions and about 50 diagrams. This treatise, entitled "Theory of the Magnocraft" (ISBN 0-9597698-1-1), is available from

ENERGY UNLIMITED

POB 35637, Sta. D, Albuquerque, NM, 87176

8. The Magnocraft — a flying vehicle utilizing the oscillatory chamber

To give some initial idea of the Magnocraft's components, shape, way of flying and possibilities, the most basic information on this spacecraft is summarized below.

a) The general design and components of the Magnocraft

The cut-away view of the Magnocraft is presented in Figure 6. Propulsion devices in this spacecraft are created by the oscillatory chambers contained within the spherical casings. Each chamber has the ability to turn in relation to the casings. Each chamber has the ability to run in relation to the casing, and, by this means, to change its inclination angle (I). The chamber, together with the casing and devices providing the turning, is called a propulsor. The Magnocraft consists of two kinds of propulsors: main (M) and side (U). The single main propulsor (M) is suspended in the centre of the craft. The magnetic poles of this propulsor are oriented so as to repel the environmental magnetic field (which could be the field of the Earth, a planet, the Sun or a galaxy). By this means, M produces a lifting force (R) which supports the craft. The magnetic axis of M is usually kept tangential to the force lines of the magnetic field existing in the craft's area of operation. Therefore the most effective orientation of the Magnocraft during flight is its base, perpendicular to the local direction of the Earth's magnetic field. Sometimes, however, this orientation must be slightly altered to fulfill the maneuvering and landing requirements. The Magnocraft consists also of numerous side propulsors (U). Their number "n" within a particular type of this spacecraft depends on the design factor called "Krotnose — K," and is described by the equation $n=4(K-1)$. The "K" factor may take any integer value in a range from $K=3$ to $K=10$. Because of the value that this factor obtains, the consecutive types of the Magnocraft are called K3 (i.e. having the K factor equal to $K=3$ — and resulting from this the number of side propulsors $n=8$), K4 (i.e. $K=4$ — and $n=12$), . . . , to K10 (i.e. $K=10$ — and $n=36$). The side propulsors are located at regular intervals in the horizontal flange surrounding the spacecraft. Their magnetic poles are oriented so as to attract the environmental field, therefore these produce attraction forces (A) which stabilize the craft and fix its orientation in space. The crew cabin (1) is located between the main (M) and side (U) propulsors, and is in the shape of a parallel-piped ring. This cabin looks similar to the side walls of an inverted saucer and is covered by a material which is impenetrable by the magnetic flux. Along the interior wall of the crew cabin lie the telescopic legs (2) of the craft, which are extended at the moment of landing.

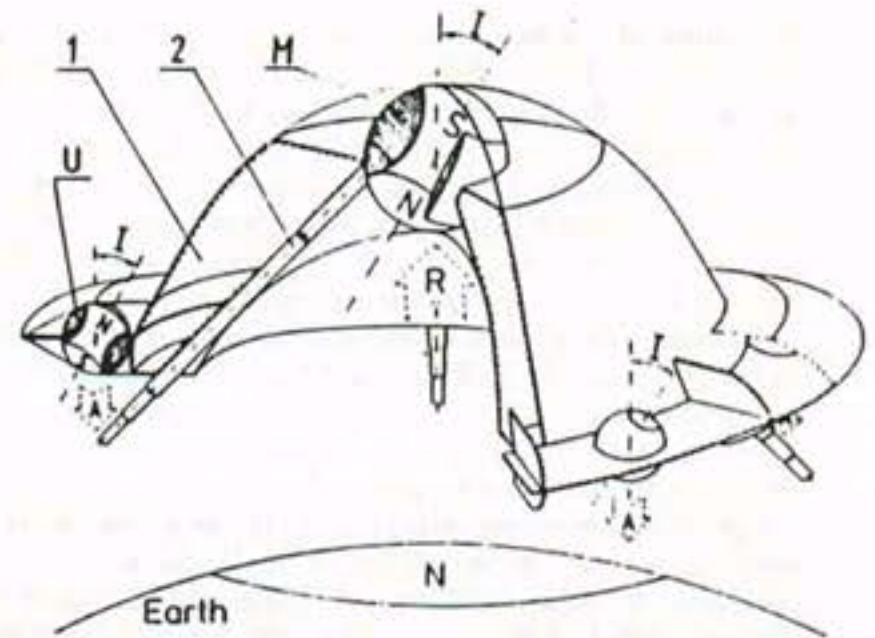

Fig. 6. Cut-away view of the Magnocraft, illustrating its internal design. The walls, made of a material impenetrable by a magnetic field, are indicated by a broken line. M — the main propulsor which produces a lifting force; U — one of the eight side propulsors which produce stabilizing forces; N — north magnetic poles; S — south magnetic poles; I — inclination angle of propulsors; A — attraction forces; R — repulsion force; 1 — the crew cabin; 2 — telescopic legs extended at the moment of landing.

b) The shape of the Magnocraft

The structure of the Magnocraft, to be stable and multi-functional, must meet a set of design requirements. These requirements demand for example, that the output from the main propulsor must be equal to the sum of outputs from all side propulsors, that the force of attraction of each side propulsor by the main one, must be in equilibrium with the forces of mutual repulsion of the same side propulsor and the rest of the side propulsors. The requirements, after their mathematical formulation, lead to the set of equations which completely defines the shape of the Magnocraft. The resultant form of these equations is given in Figure 7. One should notice that they define the shape of the Magnocraft depending only on the "K" factor, not on the craft's dimensions. Therefore several series of this craft can be designed, drastically differing in size, and ranging from a miniature, computer-controlled version to the huge, man-operated spacecraft. The shapes of individual vehicles in each of these series will be exact copies of ones from the other series; only the dimensions will be different. It is estimated that the series of crew-carrying Magnocraft should be built with dimensions fulfilling the equation: $D=6(K-2)$ metres.

c) Flight control

Maneuvering the Magnocraft is achieved as a result of a combination of three different actions.

The first of these is to change the relation between the output from the propulsors which produces attracting (A) and repelling (R) forces; this causes the ascent, hovering and descent of the craft. The second action is to slant at angle (I) the magnetic axes of certain propulsors, from their parallel orientation towards the local course of the force lines of the environmental magnetic field. This produces the meridional component of the thrust force, causing the horizontal flight of the Magnocraft from south to north or north to south. Above the equator, where the field's force lines are parallel to the ground, such a component is produced when the magnetic axes of certain propulsors are slanted from the horizontal orientation. The third action is to produce a magnetic whirl spinning around the Magnocraft and to control the direction and power of the whirl. This whirl (in a similar principle to the rotation of the cylinder in the "Magnus effect" already known in hydromechanics), produces a horizontal thrust force perpendicular to the force lines of the Earth's magnetic field. If this magnetic whirl rotates in such a way that the landing Magnocraft causes the counter-clockwise flattening of plants on the Southern hemisphere (or clockwise on the Northern), the longitudinal component of the thrust force created will propel the craft in a

A BEAUTIFUL SUNSPACE



...ALSO, AN ENERGY SAVER

ENERGY EFFICIENT is the name of the solar energy game, but graceful design and the natural beauty of wood go a long way in helping you decide among the many sunspace additions available today.

One look at a Brady & Sun Solar LivingRoom - with its unique arched wood beams and appealing architectural detail - tells the eye-pleasing story, naturally.

Of course, we've built in solar efficiency with our double-insulated glass, heat retentive walls and ceiling (R-26 value) and optional insulated shutters. And when you include the convenience of pre-cut, pre-fitted design and manufacturer's support, you'll be convinced the Brady & Sun LivingRoom has no equal in sunspace circles.

For more information on our complete sunspace line, or the name of the dealer near you, call or write:

Brady & Sun, Inc.
97 Webster Street
Worcester, MA 01603
Toll-free: 1-800-722-1900
In Mass.: (617) 755-9580



Dealership information available

AWEA	AWEA	AWEA
<p>The American Wind Energy Association (AWEA) is the trade association of the newly emerging and fast-growing wind energy industry. A non-profit corporation established in 1974 to advance the art and science of using energy from the wind, it advocates the use of wind energy conversion systems as alternatives and supplements to current energy systems that depend on depletable fuels. AWEA lobbies for wind energy, holds a major conference annually, publishes trade newsletters, and collects industry data.</p> <p>A trade association, AWEA represents manufacturers of wind systems and components, siting equipment, windfarm developers, investors, and others with an interest in wind energy. Presently AWEA maintains a membership of over 100 corporate members which include virtually every major manufacturer of wind machinery, 100 associate members, and 300 individual members.</p> <p>Alerted to legislative or regulatory issues which could affect the wind industry, AWEA plays a vital role in Washington, DC, as the representative of all parts of the industry, large and small. Since September, 1981, AWEA has been a leader in the fight to prevent repeal of the business and residential energy tax credits, an issue of crucial importance to all segments of the industry. AWEA is fighting right now in Washington to preserve and extend these energy tax credits.</p> <p>Since AWEA is the only national organization devoted exclusively to wind energy, its National Conference and Wind Energy Expo is a major industry gathering, which offers speakers and exhibitors direct contact with the entire wind energy market. Investors, developers, manufacturers, component suppliers, dealers, researchers, government officials, and international wind industry representatives will be found in attendance.</p> <p>To promote the widespread use of wind as a renewable, non-polluting energy source, AWEA helps provide communication within the field of wind energy, the technical community and the general public. Producing a variety of publications from a "Windfarm Listing" to a weekly newsletter, "AWEA Wind Energy Weekly", AWEA is able to provide timely accurate information about industry news, legislative developments, international issues, research developments, technical findings and market forecasts. AWEA is rapidly becoming the information source on wind energy.</p> <p>AWEA also conducts a variety of research tasks to develop wind industry statistics and analysis producing a wealth of information. Along with these efforts AWEA also has moved steadily forward in its efforts to develop voluntary consensus standards for SWCS. Responsibly drawn standards from the industry itself are vital to a "healthy" industry.</p> <p>In short, from providing the most timely information affecting the industry to standing up for the rights of wind energy manufacturers and consumers in regulatory forums across the country, from helping protect solar tax incentives to developing the industry's political "clout", AWEA works for wind energy.</p> <p>The association is a key force in working for the wind industry as well as an effective spokesman for wind energy. Wind energy can supply a substantial portion of America's energy needs through a domestic, renewable, non-polluting, non-inflationary "fuel" -- SOMETHING WHICH WILL BENEFIT EVERY ONE OF US.</p>		
<p>1516 King Street, Alexandria, Va. 22314 Tel. (703) 684-5196</p>		

direction from west-to-east. The opposite rotating whirl will propel the craft from east to west. The magnetic whirl is produced by the appropriate synchronization of the outputs from the side propulsors, pulsating with the phase shifts.

From the above explanation it is evident that all flight control activities can be achieved without the relative mechanical movement of any part of the Magnocraft, but only by slanting the whole spacecraft and controlling the outputs from its propulsors. Therefore, miniature, computer-operated versions of this vehicle will be built, without a single moving part. This craft will be the only example of a precisely controlled vehicle which does not consist of any moving part. In the big, man-operated versions, however, for the convenience of the crew, it will be better to replace the slanting of the Magnocraft by tilting the axes of its propulsors (especially when it comes to landing). In such versions, the propulsors will be rotary, as was described previously. Sometimes, especially in the smaller types K3 and K4 of the man-operated Magnocraft, to save space a compromise solution is possible, when the main propulsor is fixed and consists only of the oscillatory chamber joined to the structure of the craft, whereas the side propulsors are rotary (i.e. their chambers revolve toward spherical casings).

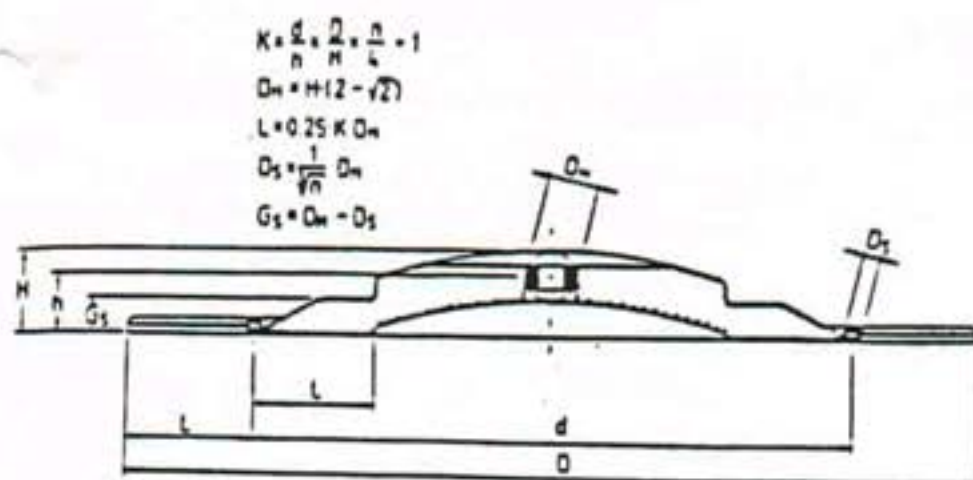

Fig. 7. The compendium of basic equations which combine the most important parameters describing the shape of the Magnocraft's structure. An interpretation of the dimensions involved is shown in an outline of the K10 type of craft. 'H' is the height of the craft (base to top); 'D' is the outer diameter of the craft; D_M and D_S are the diameters of the spherical casings that cover the main and the side propulsors; 'K' represents the 'Krotnosk' factor which in consecutive types of craft takes the integer values ranging from $K = 3$ to $K = 10$ (for the craft type K10 this factor takes the value $K = 10$); 'n' represents the number of side propulsors.

d) The specifications of the Magnocraft

The unlimited prospects that the building of the Magnocraft will create for humanity can be realized from the following review of the properties of this vehicle.

The spinning magnetic field will cause cumulative ionization of air, forcing the creation of a glowing plasma whirl surrounding the spacecraft. The centrifugal forces acting on each particle of air in this whirl, will reject the air out of the surface of vehicle, forming a kind of a local vacuum duct in which the craft will fly without friction. This will allow the Magnocraft to reach a speed of about 70,000 km per hour in the atmosphere, apart from the flights close to the speed of light in free space. The vacuum layer surrounding the craft will also protect it from heat action during flights in melted media. The silent character of magnetic interactions in connection with the elimination of a frontal pressure by the plasma whirl will make the Magnocraft noiseless in flight. The plasma whirl will also form a kind of circular saw of enormous power, which will enable this vehicle to gnaw through solid matter (e.g. rock, buildings, bunkers, etc.) creating glassy tunnels. The centrifugal action of the plasma whirl, supported by the forces of magnetic interactions between the craft's propulsors, forming a kind of magnetic framework, will provide the Magnocraft with the ability to withstand any high environmental pressure. The spinning magnetic field will induce electric currents in the conductive materials in the vicinity, changing them into



Coyne Solar Company

Sun Challenger™
from Coyne Solar Company
World's First
made by electricity
from the sun!



PO Box 1120 • San Juan Pueblo, New Mexico 87068
(505) 852-2622
Member N.M.S.E.I.A.
New Mexico Solar Energy Industry Association



PHOTOCOMM INC.

PHOTOVOLTAIC SYSTEMS

7735 East Redfield Road
Scottsdale, AZ 85260

explosives. This will form around the Magnocraft a kind of inductive shield, providing it with the ability to oppose any weapon that our present military techniques may use against it. When, on a command from the crew, the spinning magnetic field is changed into a steady, constant one, the above properties will disappear. However, in this case a kind of magnetic lens will be formed around the craft. This will make the Magnocraft invisible to radar and to the naked eye. During any kind of flight, the operation of this vehicle will be pollution-free.